

St Lawrence Churchyard Monumental inscriptions - Area H

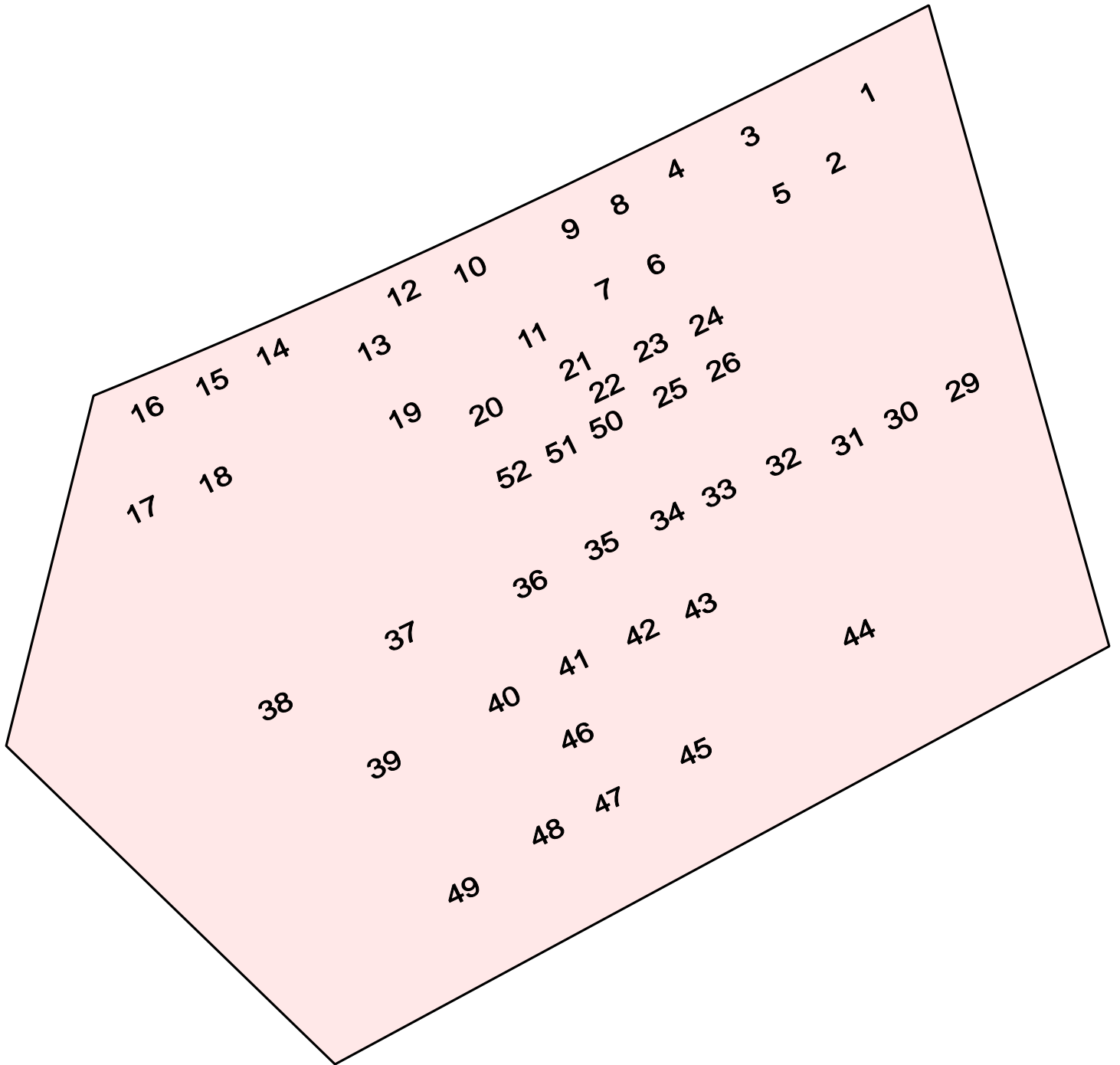

A General View of Area H



A General View of Area I



I

H

In
Loving Memory
of
CHARLES WILLIAMS WYNNE
son of
THOMAS & ELLEN WYNNE
WHO ENTERED INTO REST JULY 14 1901
AGED 35 YEARS

Marble Cross on Stepped Plinth.

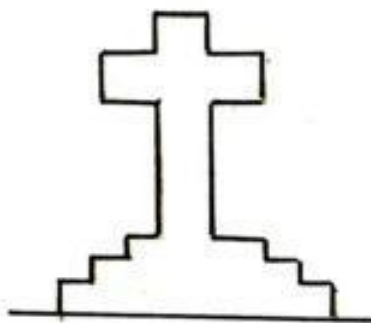

In the Memory of

JAMES BELCHER

of Morrton -ark

BORN NOVEMBER 28 1799

DIED MARCH 10 1881

Surely goodness and mercy
shall follow me all the days
of my life

ANN,

BELOVED WIFE OF THE ABOVE

BORN30 1809

..... 24 1889

BETH BELCHER

..... THE ABOVE

..... 18.2

..... 19.2

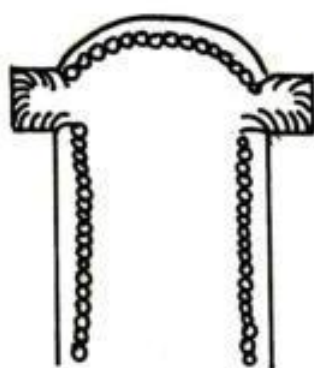

surrounded by low
railings

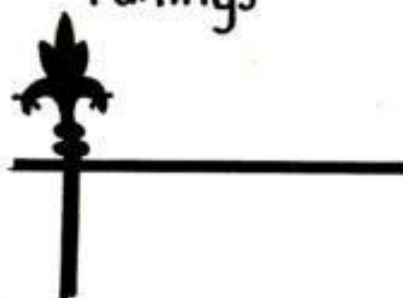



Loving Memory
of

SAMUEL ADDISON

WHO DIED OCT. 28TH 1897

AGED 79 YEARS

NOT MY WILL BUT THINE
BE DONE

MARY ADDISON

WHO DIED NOV. 8TH 1892

AGED 91 YEARS

HER END WAS PEACE

SARAH ADDISON

WHO DIED MARCH 8TH 1901

AGED 89 YEARS

THY WILL BE DONE

FOR IF WE BELIEVE THAT JESUS DIED AND ROSE AGAIN
EVEN SO THEM ALSO WHICH SLEEP IN JESUS WILL
GOD BRING WITH HIM THESS 4TH 14TH

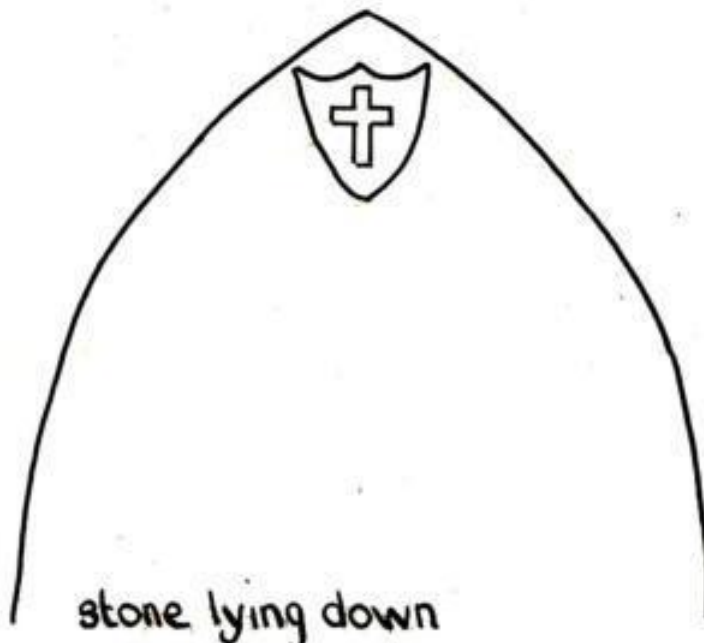

In Affectionate
Remembrance of
MARJORIE MARY
INFANT DAUGHTER OF
HENRY AND MARIE ADDISON
WHO DIED 20TH JAN 1891

Marble Cross on Stepped Plinth

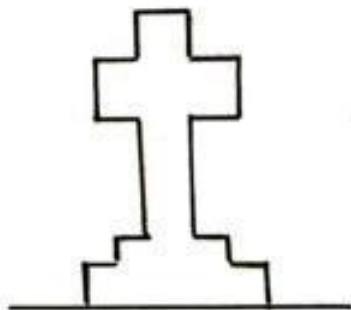

In Loving Memory of
ARTHUR BUCKLEY

of Befcote

WHO DIED MAY 29 1888

AGED 52 YEARS

In the midst of life we are in death

ALSO

MARGARET WIFE OF THE ABOVE

who died February 7th 1906

AGED 77 YEARS

THY WILL BE DONE



surrounded by low railings



6

H

IN
LOVING MEMORY
OF
ANNIE JANE

WIFE OF R. STEWART STEELE
WHO DIED JUNE 5th 1897 AGED 36 YEARS

Sandstone cross on stepped plinth

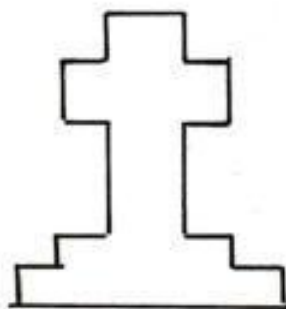

Enclosed by low railings with

H, 7, 8 + 9

IN LOVING MEMORY OF
JOHN TILL M.A.
FELL ASLEEP JULY 18TH 1901 AGED 92
FOR 56 YEARS VICAR
OF THIS PARISH



Enclosed by low railings with H6,8,9.

8

H

In
Loving Memory
of
REV^d H. TILL B.A.
WHO DIED MARCH 30TH 1884
Aged 25 Years
HE GIVETH THIS BELOVED SLEEP

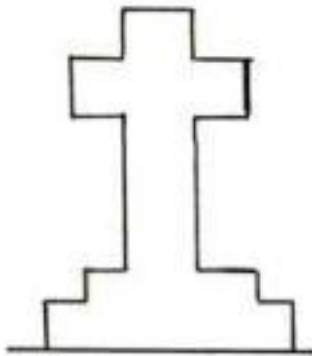

Enclosed by low railings with 6, 7 & 9

IN MEMORIAM
MARY
RELICT OF THOMAS TILL MANOR HOUSE
WHITGREAVE
----- EMBER 1862

Plinth only enclosed by low railings
with 6, 7+8

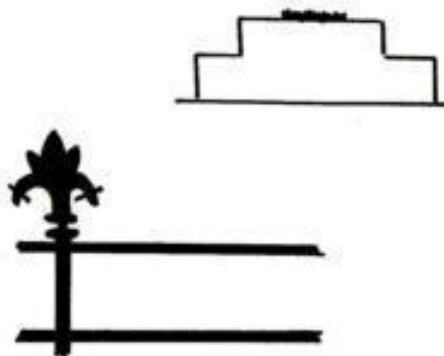

IN LOVING MEMORY OF

HANNAM

daughter of the late W. Timmis

DARLASTON WOOD STONE

who entered into rest May 12 1891

AGED 72 YEARS

THE MEMORY OF THE JUST IS BLESSED

ALSO

MARY ANNIE TIMMIS

Sister of the above

Entered into rest June 28th 1899

Rectangular sandstone lying down

In
Memorian
MABEL KATHLEEN
DAUGHTER OF
J. EDWARD AND
KATE GABB

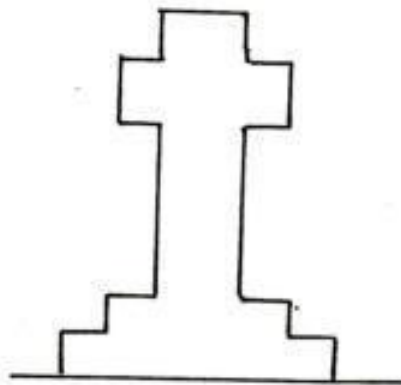

SACRED

TO THE MEMORY OF

RICHARD ANSLOW
For more than 40 years
Parish Clerk of Gnosall
DIED 13th NOVEMBER 1897
Aged 75 Years

ANN wife of
RICHARD ANSLOW
who died
FEB. 22nd 1874
Aged 73 Years
Blessed are the dead
That die in the Lord

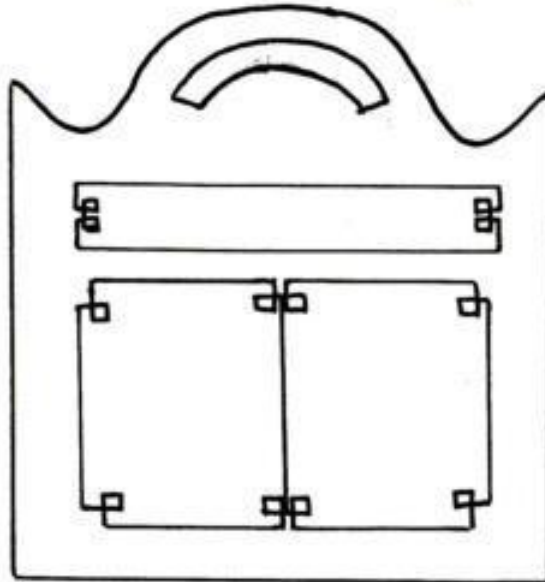

IN
AFFECTIONATE REMEMBRANCE
OF
JAMES BELLINGHAM
Brook House. Gosall
Who Died June 11th 1896
AGED 85 Years

ALSO

FANNY. WIFE OF THE ABOVE
Who Died March 8th 1900
AGED 83 YEARS

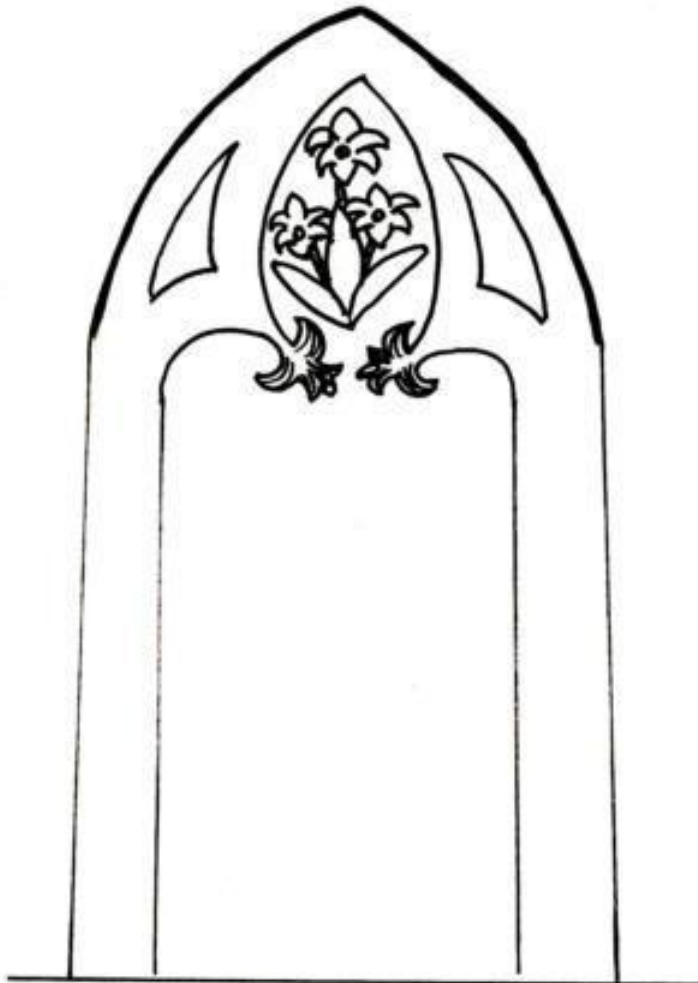

In affectionate memory
of

WILLIAM PODMORE



who died at Gnosall

1st September 1875

aged 46 years

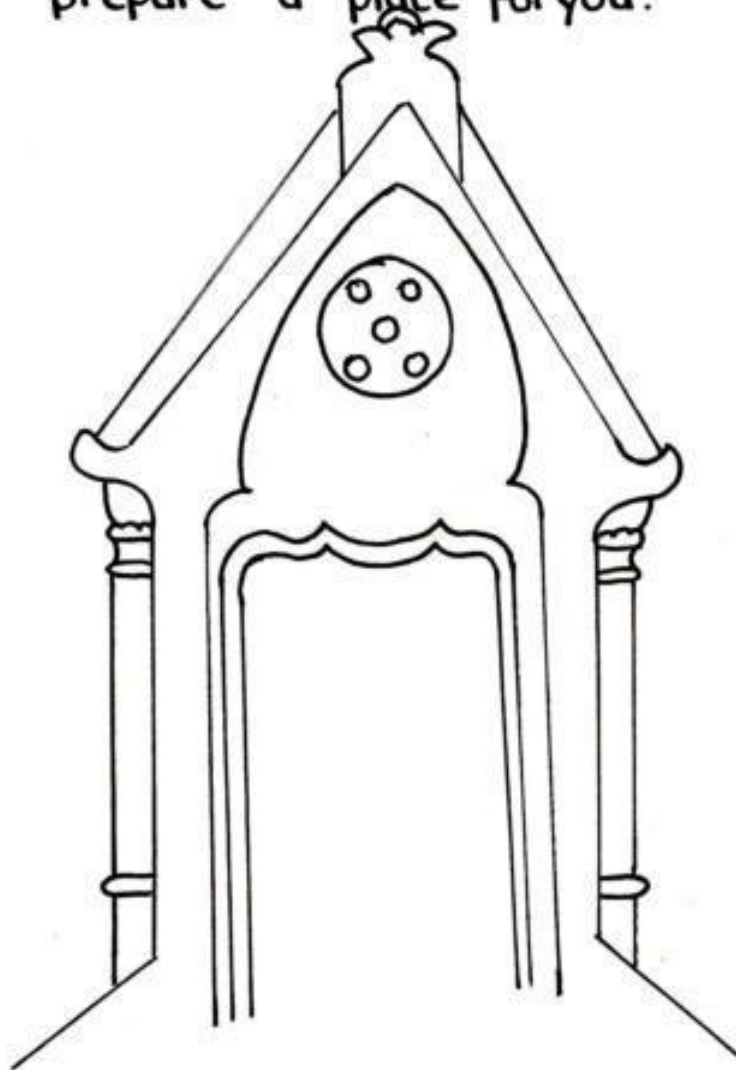
In My Fathers house are many
mansions, if it were not so I
would have told you. I go to
prepare a place for you.



IN LOVING MEMORY OF

 JOHN MADELEY

OF GNOSALL HEATH
 who died April 15TH 1900
 AGED 91 YEARS

HARRIET WIFE OF THE ABOVE
 who died March 7TH 1901
 AGED 92 YEARS

"THERE SHALL BE NO NIGHT THERE"



IN LOVING  MEMORY OF
ANN

THE BELOVED WIFE OF JOHN WHITMORE

OF COTON WOOD

Died June 21st 1898.

Aged 77 Years

—
Also

JOHN WHITMORE

THE DEARLY BELOVED HUSBAND OF THE ABOVE

Died March 15th 1908

Aged 88 Years

—
INTERED AT AUDLEM CEMETERY MARCH 19TH

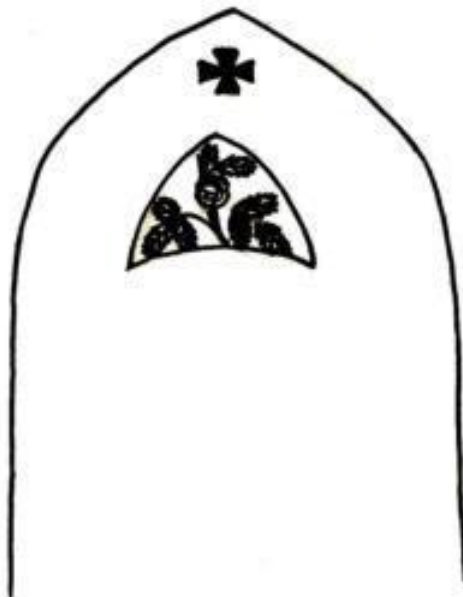

In Memory of
HANNAH, the daughter of WILLIAM
and SARAH REYNOLDS, died 19th
March 1823 Aged 17 Years
Here you see the Young and blooming fall
for fatal death shows no respect at all
Also His Son WILLIAM died 19th May
1823 Aged 22 Years

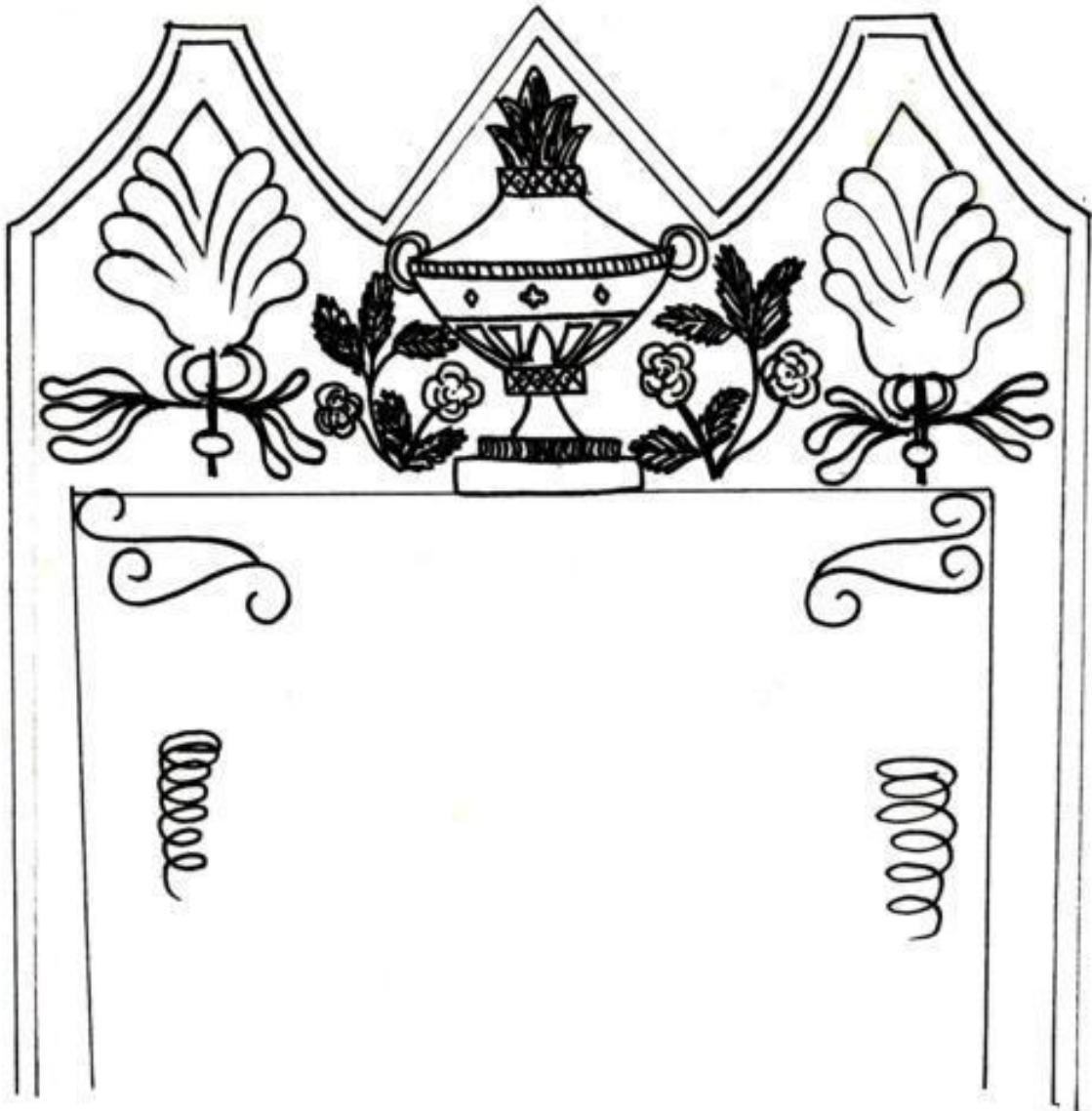

IN AFFECTIONATE
 REMEMBRANCE OF
 WILLIAM BRATT
 (of Gnosall Heath)
 Died Feb²⁷ 14th 1846 Aged 66 Years

ALSO

ANN THE BELOVED WIFE OF THE ABOVE
 Died June 29th 1883 Aged 86 Years

Blessed are the dead that die in the Lord
 Also

ELIZABETH Daughter of the above
 Died July 16th 1898 Aged 76 Years

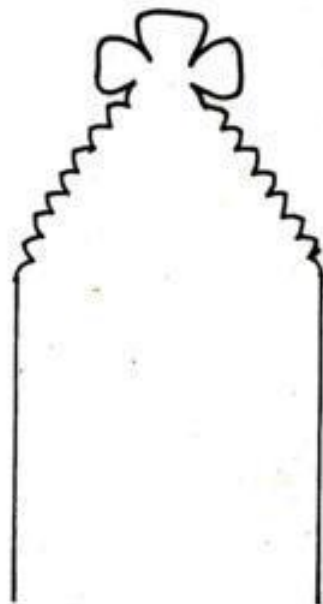

MEMORY OF
JAMES BELLINGHAM

LATE OF LO.....ON

Who Died at Burslem
July 1ST 1884 Aged 38 Years

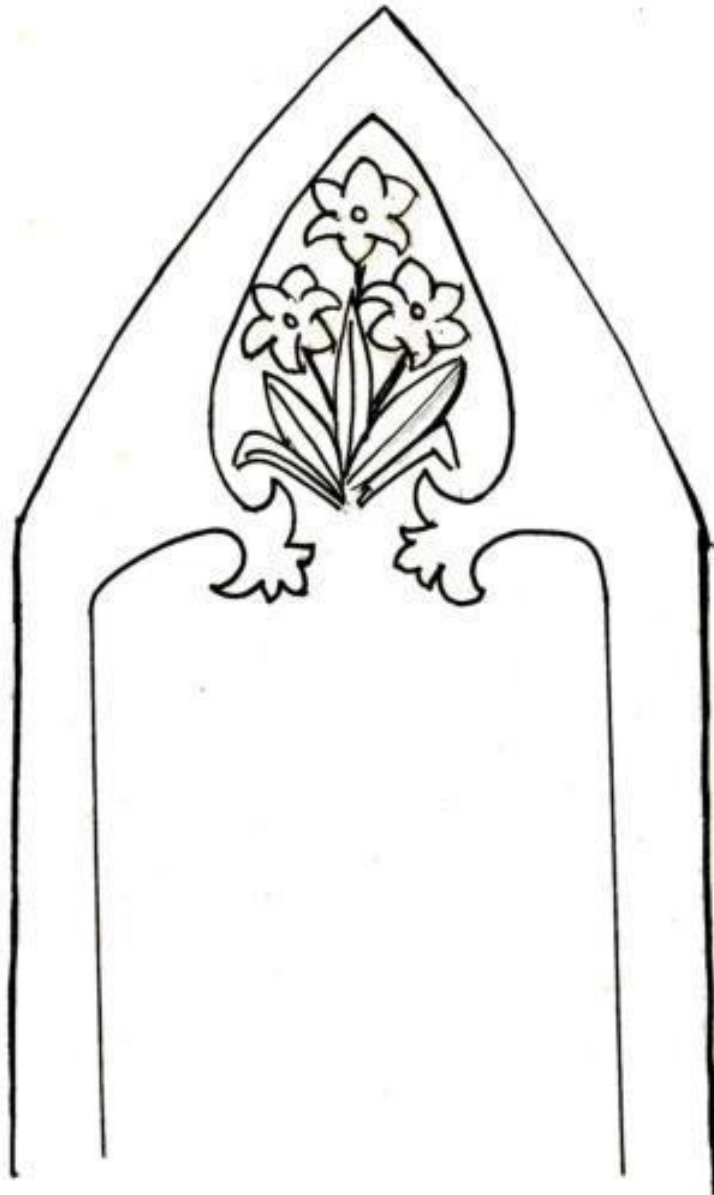

IN
LOVING MEMORY
OF
HENRY, THOMAS BLEWITT
OF WOOD HOUSE GNOSALL
DIED JANUARY 17, 1896
AGED 50 YEARS

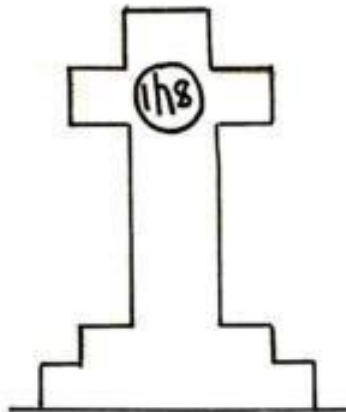

Sacred
TO THE MEMORY OF
REGINALD EDMUND BAUGUST
BORN MARCH 3RD 1890
DIED NOVEMBER 28TH 1895

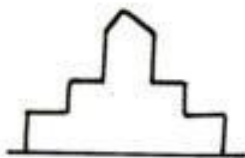

JOHN GREADEP BELCHER

WHO DIED MARCH 6TH 1927 AGED 56

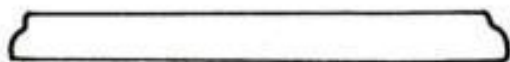

strip of stone enclosed by railing with
H 23, 24, 25 + 26

IN
LOVING MEMORY
OF
HARRIET WELLINGS
(DELLY)
DIED NOV. 22ND 1906

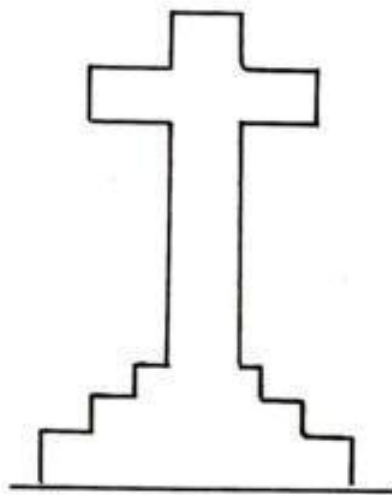

Enclosed by railings with H22,24,25,26

IN LOVING MEMORY OF
SUSAN CHARLOTTE
BELCHER

DIED 24TH JULY 1931

AGED 61

ALSO

HENRY MICHAEL
BELCHER

DIED 13TH JUNE 1935 AGED 70

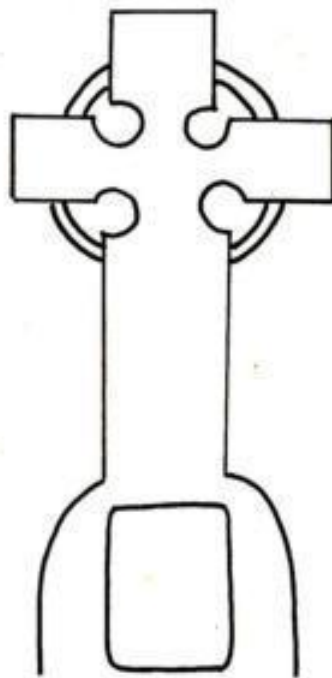

Enclosed by railing with H22,23,25+26

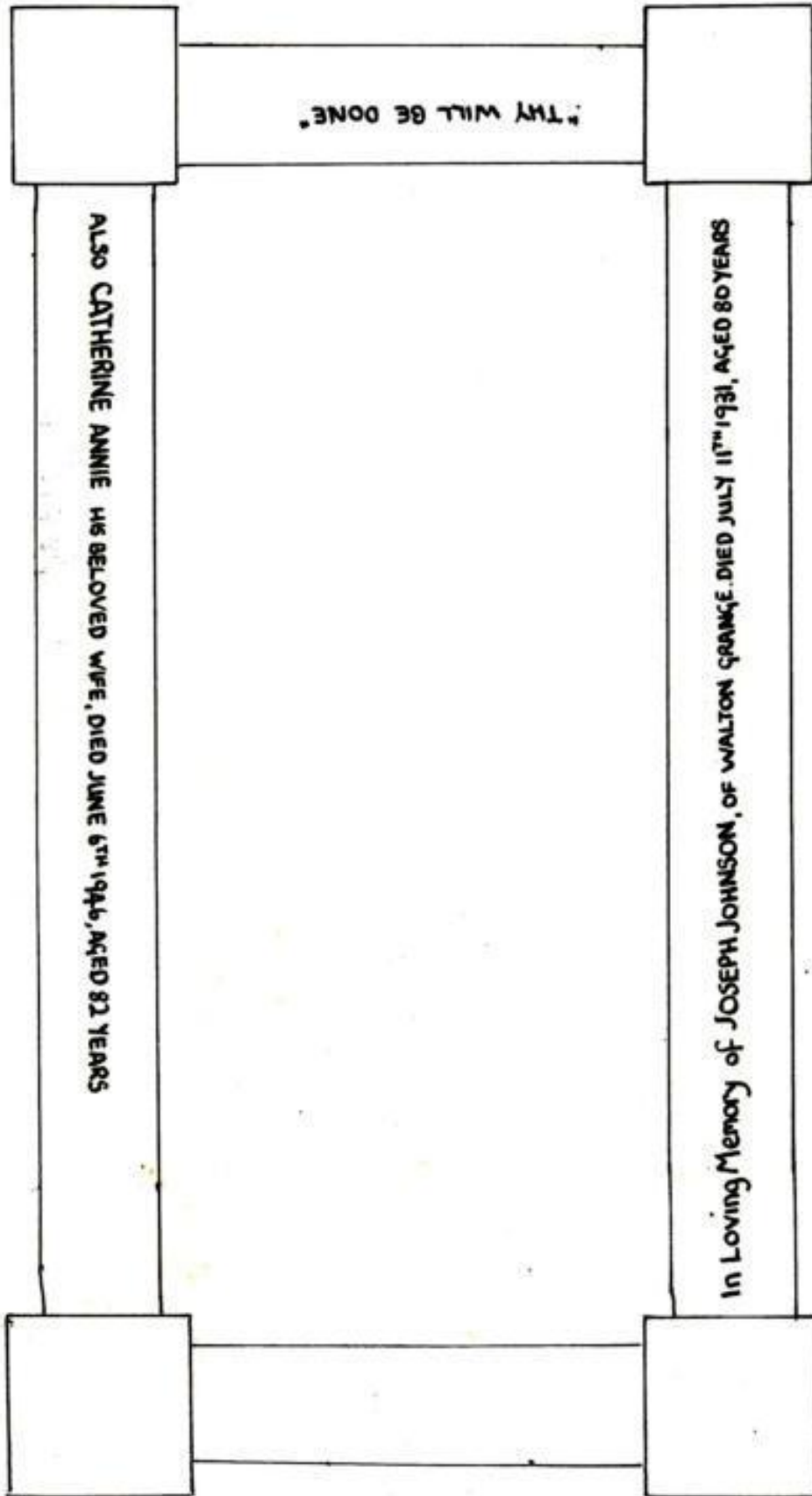

IN AFFECTIONATE
REMEMBRANCE OF
THOMAS BELCHER
LATE OF THE WEIRLANDS
DIED FEBY 10TH 1910
AGED 72 YEARS

—
THY WILL BE DONE

—
ALSO OF HIS BELOVED WIFE
HARRIETTE LOUISA
DIED JANY 11TH 1911 AGED 72

—
THE WEARY ARE AT REST

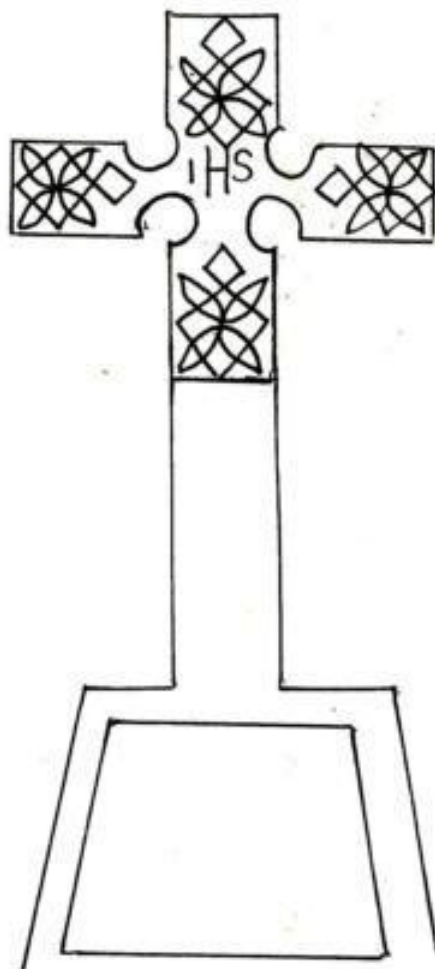

In
Loving Remembrance
of
ELIZA JANE FOSTER
WHO DIED MAY 18TH 1886
AGED 65 YEARS

My race is run my pain is o'er
I'm from affliction free
My loving friends and kindred dear
Prepare to follow me

Also
JOSEPH FOSTER
WHO DIED MAY 5TH 1895
AGED 86 YEARS

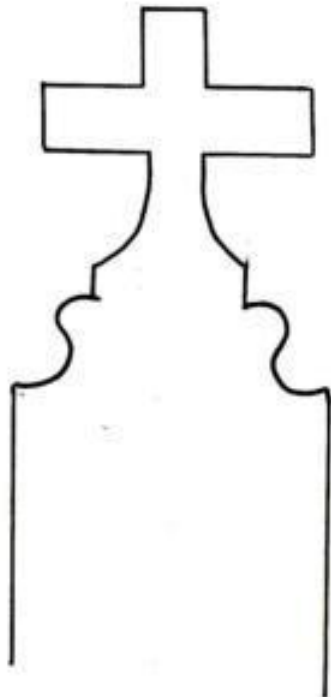

In Loving Memory of
THOMAS WYNNE
THE MANOR HOUSE, GNOSALL
DIED JUNE 4TH 1891
Aged 84 Years
"WRITE HIM AS ONE WHO LOVES
HIS FELLOW MEN
Also of ELLEN his wife
WHO DIED SEP. 19TH 1896
Aged 62 Years
"PEACE PERFECT PEACE"

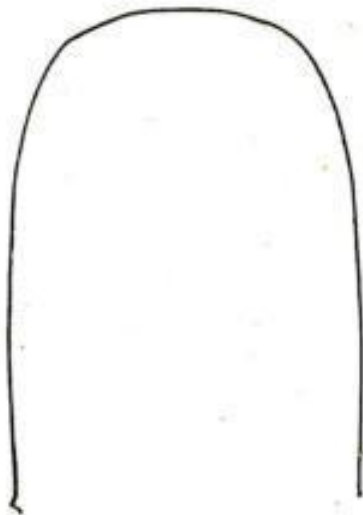

Surrounded by railings

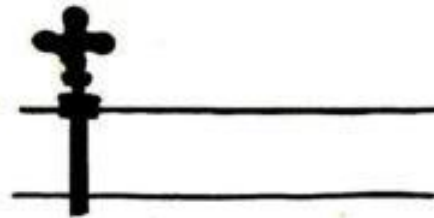

IN AFFECTIONATE REMEMBRANCE OF

MARY

WIFE OF FRANCIS AMIES

OF GNOSALL

WHO DIED JULY 20TH 1882

AGED 69 YEARS

A FEW MORE YEARS SHALL ROLL

A FEW MORE SEASONS COME

AND WE SHALL BE WITH THOSE THAT REST

ASLEEP WITHIN THE TOMB

THE TIME IS SHORT

ALSO OF FRANCIS AMIES, WHO DIED

JANUARY 28TH 1885 AGED 87

DAY BY DAY THE VOICE SAITH COME

ENTER THINE ETERNAL HOME

ASKING NOT IF WE CAN SPARE

THESE DEAR SOULS IT SUMMONS THERE

ALSO OF FRANCIS AMIES SON OF THE ABOVE

WHO DIED JANUARY 6TH 1910 AGED 62 YEARS



In Affectionate
of
Remembrance

WILLIAM PEARCE

(of -----)

who died December 24th 1882

Aged 55 Years

Weep not for me ----- free from pain

My earthly sufferings O're

I have to meet you all again

On a peaceful happy shore



IN
BELOVED REMEMBRANCE
OF
WILLIAM HENRY
JENNINGS
who died Nov^r. 16th 1884

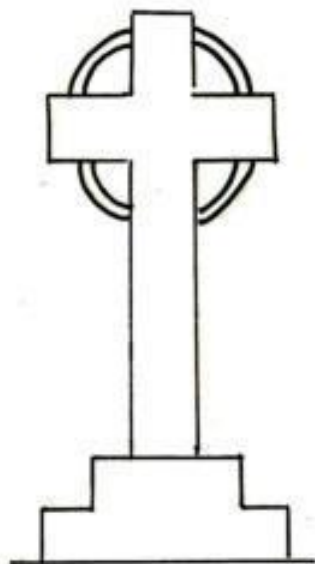

In Loving Memory of
 JOHN SHAW
 of Brook House Gnosall
 who Departed this life Nov 7th 1884
 Aged 73 Years

THE BOREAS BLAST AND NEPTUNES WAVE
 HAVE TOSSED ME TOO AND ----
 IN SPITE OF ALL BY GOD'S DECREE
 I HARBOUR HERE BELOW
 THOUGH HERE AT ANCHOR WE DO LIE
 WITH MANY MORE OF OUR FLEET
 WE SHALL SET SAIL ONE DAY AGAIN
 OUR SAVIOUR CHRIST TO MEET

ALSO

ELIZA wife of the above
 who departed this life April 8th 1903
 THY WILL BE DONE

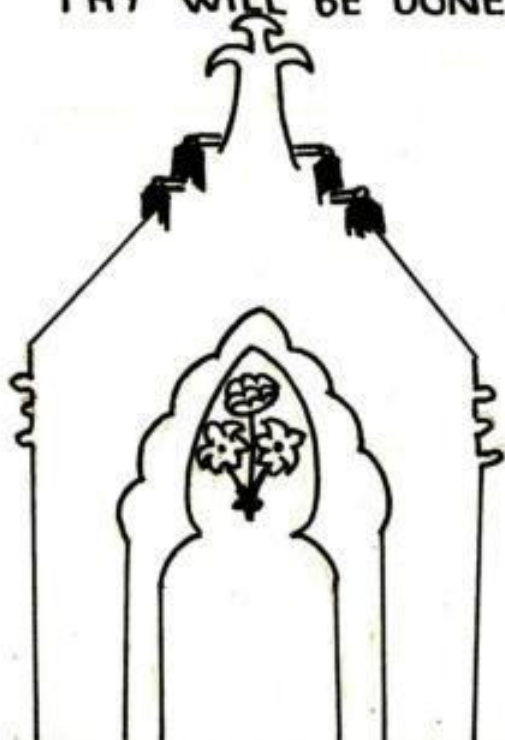

In
Loving Memory of
LETITIA
the beloved and faithful wife of
WILLIAM WHITE of Gnosall
who departed this life Sep^r 19th 1884
Aged 49 Years
HER END WAS PEACE
"PREPARE TO MEET THY GOD"
Also of
ELIZABETH ANN
daughter of the above
died Feb 14th 1940
Aged 78

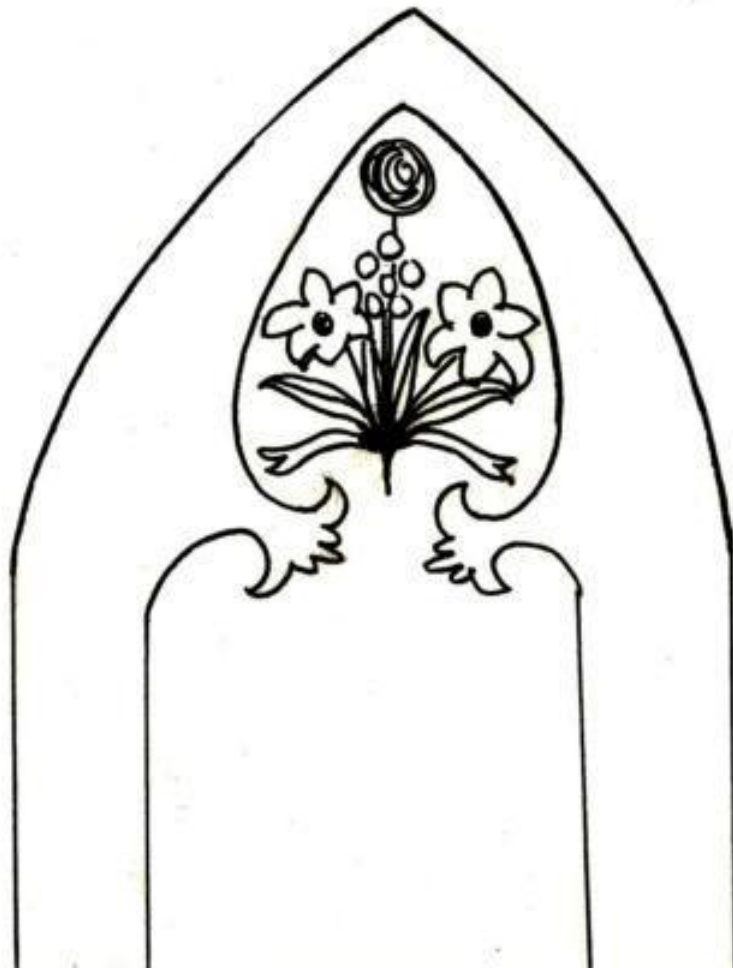

IN LOVING MEMORY OF
JAMES GARDNER
who died October 14th 1897
AGED 73 YEARS

THY WILL BE DONE
ALSO

MARY WIFE OF THE ABOVE
who died August 28th 1901
AGED 68 YEARS

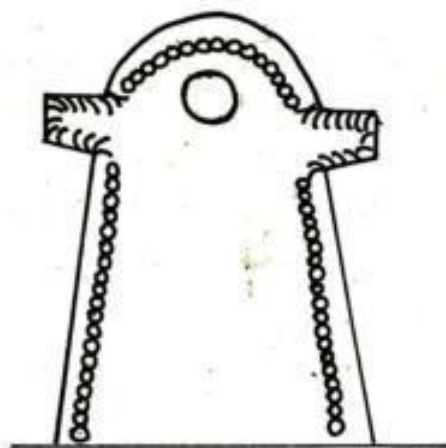

who died 17th ----- 1878
Aged 4 -- Years

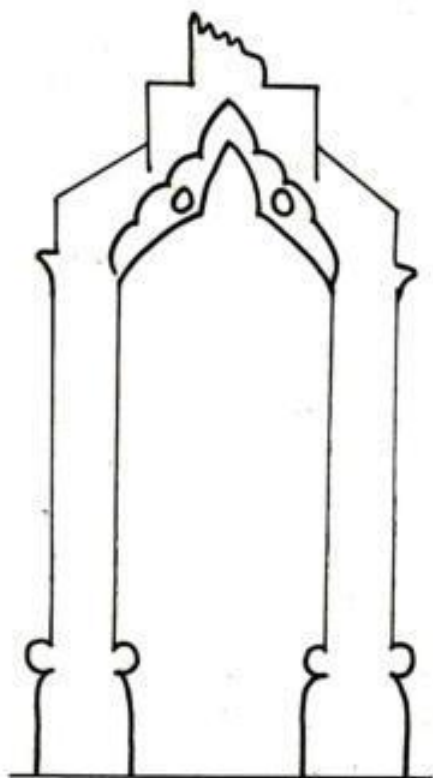

In
Affectionate Remembrance
of
JOSEPH PARTON
of Cowley
who died, June 6, 1879
Aged 78 Years

Also of SARAH
his beloved wife
who died, April 7, 1877
Aged 73 Years

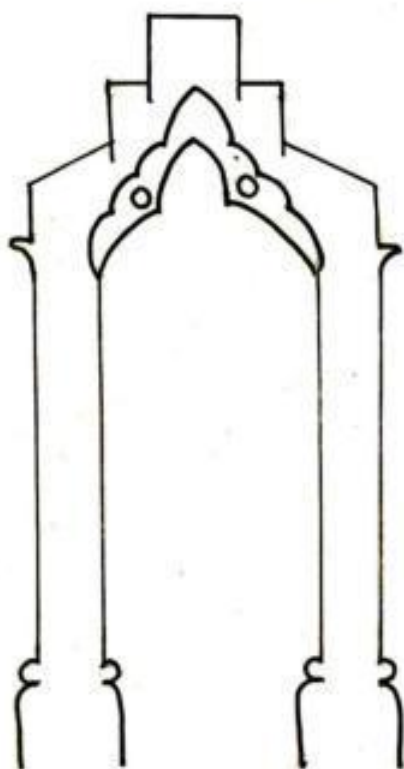

IN LOVING

MEMORY OF



JOHN YATES

(OF MOOR END FARM, GNOSALL)

who departed this life

December 28th 1898

AGED 55 YEARS

"NOT MY WILL BUT THINE BE DONE"

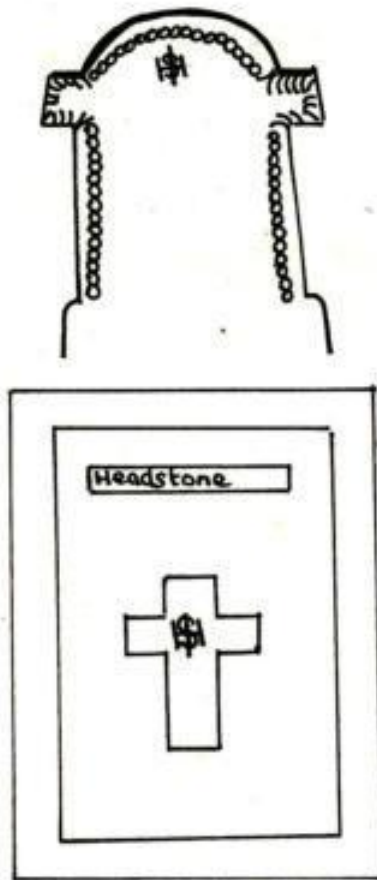

Headstone set in stone base
with low-walled surround

In Loving Memory of
MARY ANN CLARKE NEWTON
WIFE OF HENRY NEWTON OF GNOSALL
WHO DIED JANUARY 13 1899

IN HER 71ST YEAR
"SHE HATH DONE WHAT SHE COULD"

Also OF THE ABOVE
HENRY NEWTON
WHO DIED DECEMBER 10 1902
IN HIS 85TH YEAR

Also of
THEIR SECOND SON
WILLIAM
WHO DIED NOVEMBER 23 1902
AGED 47 YEARS



SACRED
to the Memory of
JAMES ALLEN

LATE OF KNIGHTLEY HALL
WHO DEPARTED THIS LIFE
JANUARY 9TH 1862
AGED 66 YEARS

Blessed are the dead
that die in the Lord

ALSO MARY ALLEN
WIFE OF THE ABOVE
WHO DEPARTED THIS LIFE
SEPTEMBER THE 12 1860
AGED 66 YEARS

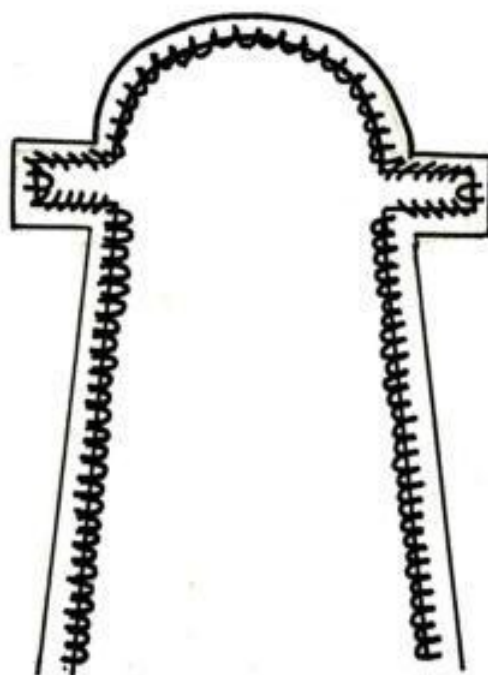

stone facing
west

IN AFFECTIONATE

REMEMBRANCE OF

ALICE-ELIZABETH
THE DEARLY BELOVED CHILD OF
ARTHUR HOPKINS & ELIZABETH GORD
OF BRINETON
WHO DIED 28 MARCH 1872
AGED 4 YEARS & 11 MONTHS

Suffer little children to come unto me
forbid them not for of such is the Kingdom
of Heaven



H46 and H47
in the background

IN AFFECTIONATE  REMEMBRANCE OF

ANN

relict of the late Richard Johnson
of Hanley Staffordshire

WHO DIED 22 AUGUST 1871

in her 70th year

ALSO

of MARY the beloved wife of
Joseph Parton of Cowley

AND DAUGHTER OF THE ABOVE

WHO DIED 11 AUGUST 1884

aged 50 years

THY WILL BE DONE

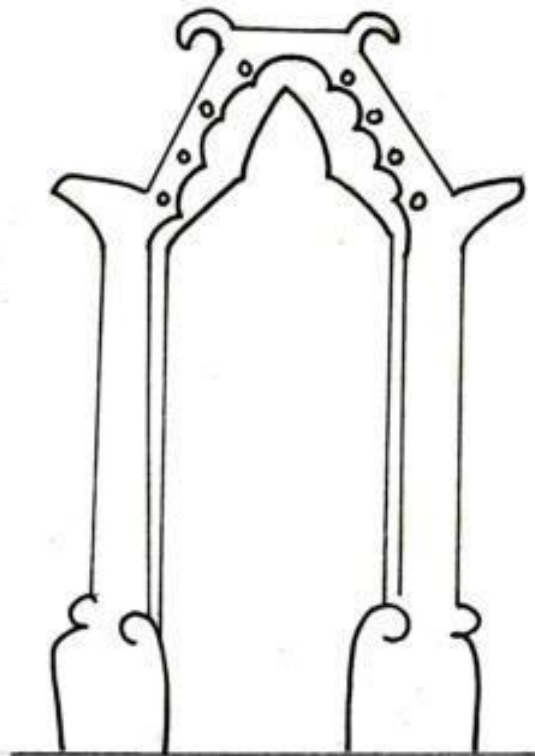

In Loving Memory
of
JOSEPH PARTON
OF EDGMOND
late of Cowley Staffordshire
WHO DIED FEB 28 1890
Aged 53 Years
INTERRED AT GNOSALL MARCH 4th
His end was peace

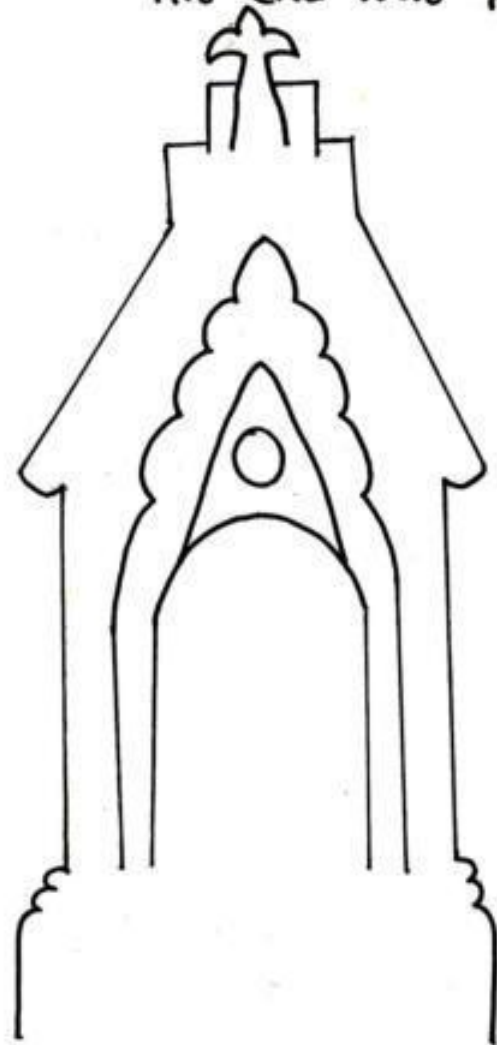

In affectionate remembrance of

JAMES PARZON

who died 17 October AD 1874

aged 60 years

Come unto me all ye that labour and are heavy laden and

I will give you rest

Also ESTHER wife of the above

who died May 30th 1898

Aged 66 Years

Come unto me ye weary and I will give you rest



IN REMEMBRANCE OF

.....E BYRD

.....Apeton)

.....the life Nov^r 16th

1882 Aged 66 years

Affliction sorrlongtime I bore

Please My life to take and free

Me of my pain

Lord what is my hope

Truly my hope is even in thee

Also

MARY ANN

the beloved wife of George Byrd

DIED MAY 24TH 1890

Aged 80 Years

Blessed are the dead that die

in the Lord even so saith the

Spirit for they rest from their

labours

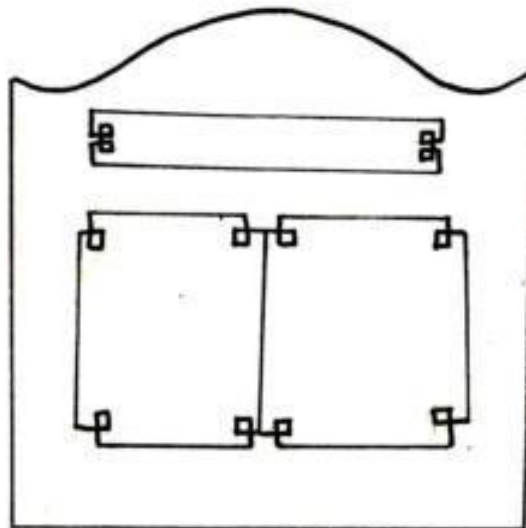

Edward William
Belcher

DIED AUGUST 16TH 1939

AGED 71 YEARS

ALSO

Frances Ann,

HIS WIFE

DIED DEC 17TH 1940

AGED 75 YEARS

BOTH INTERRED AT

WESTCLIFFE ON-SEA

(West Side)

Esther Sarah

Chinery

DAUGHTER OF

HENRY BELCHER

WHO PASSED AWAY

JULY 15TH 1949

AGED 85 YEARS

(North Side)

IN MEMORY OF

Henry Belcher

LATE - OF - GNOSALL

DIED AT DULWICH FEB^{RY} 20TH 1909

INTERRED HERE FEB^{RY} 23RD 1909

AGED 72 YEARS

ALSO OF

Mary Eleanor

HIS SECOND WIFE

WHO DIED APRIL 30TH 1900

INTERRED AT SANDOWN I.O.F.W.

AGED 57 YEARS

(West Side)

Arthur Jackson-

Belcher

Died 17th January 1983

Aged 80 years

IN MEMORY

OF

Mary Ann

WIFE OF

Henry Belcher, Wharf house

GNOSALL

WHO DIED MARCH 16TH 1873

AGED 40 YEARS

ALSO OF
 Charles Herbert Belcher
 WHO DIED AT CATERHAM SURREY
 ON JANUARY 3RD 1939

AGED 67 YEARS
 James Arthur Belcher, M.D.
 DIED SEPTEMBER 1ST 1960
 AGED 91 YEARS

Fanny Louisa
 WIFE OF THE ABOVE
 DIED OCTOBER 23RD 1957
 AGED 87 YEARS

Blessed are the pure in heart

Mary
 SISTER OF
 HENRY BELCHER
 DIED AT HEATH HOUSE, GOSALL

JUNE 23RD 1912
 AGED 80 YEARS

Mary Ann
 DAUGHTER OF
 HENRY BELCHER
 DIED AT CATERHAM
 JAN 30TH 1948 IN HER 79TH YEAR
 AND WAS INTERRED AT GOSALL



Edward William
Belcher

DIED AUGUST 16TH 1939

AGED 71 YEARS

ALSO

Frances Ann,

HIS WIFE

DIED DEC 17TH 1940

AGED 75 YEARS

BOTH INTERRED AT

WESTCLIFFE ON-SEA

(West Side)

Esther Sarah

Chinery

DAUGHTER OF

HENRY BELCHER

WHO PASSED AWAY

JULY 15TH 1949

AGED 85 YEARS

IN EVER LOVING MEMORY

OF

ANN BROOMHALL

BORN MAY 29TH 1831

DIED OCT 10TH 1882

ALSO OF

SARAH ANN LIVERSAGE

BORN APRIL 4TH 1861

DIED FEB. 27TH 1887

"WITH CHRIST WHICH IS FAR BETTER"

ALSO OF

JOHN LIVERSAGE

HUSBAND OF THE ABOVE

DIED NOV 3RD 1946

AGED 88 YEARS

REUNITED



IN MEMORY OF
SARAH BIDDLE
OF COTON HOUSE
BORN FEB. 1. 1791
DIED APL. 14. 1875

ALSO

JOHN BIDDLE
BORN Oct. 21. 1808
DIED Oct. 23 1876
"WITH JESUS"

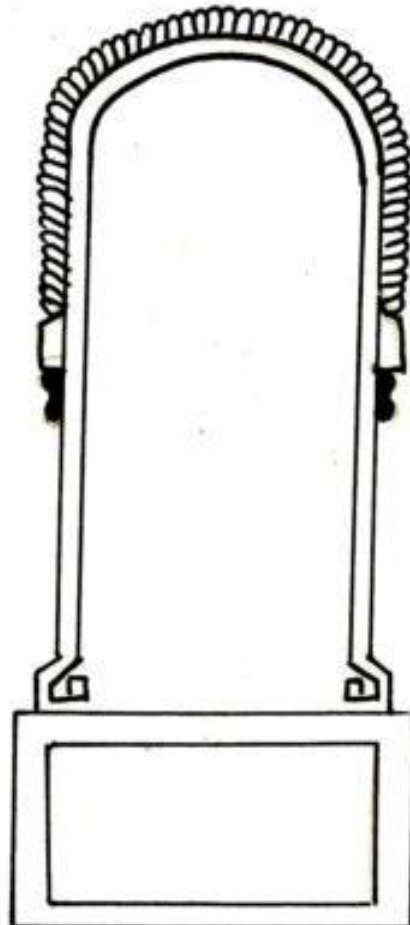

In Affectionate
Remembrance of
CHARLES BIDDLE
Of Wednesbury
WHO DEPARTED THIS LIFE
MAY THE 16TH, 1880
AGED 55 YEARS

Home at last thy labour done. Safe and bless
the Victory won Jordan past from pain set
free Angels now have welcomed thee

Also of EDWIN BIDDLE,
Of Wednesbury, late of Gnosall
Who departed this life August 14 1881
AGED 67 YEARS

I have blotted out cloud,
Any transgressions, and as a cloud thy sins
Return unto Me, for I have redeemed thee."

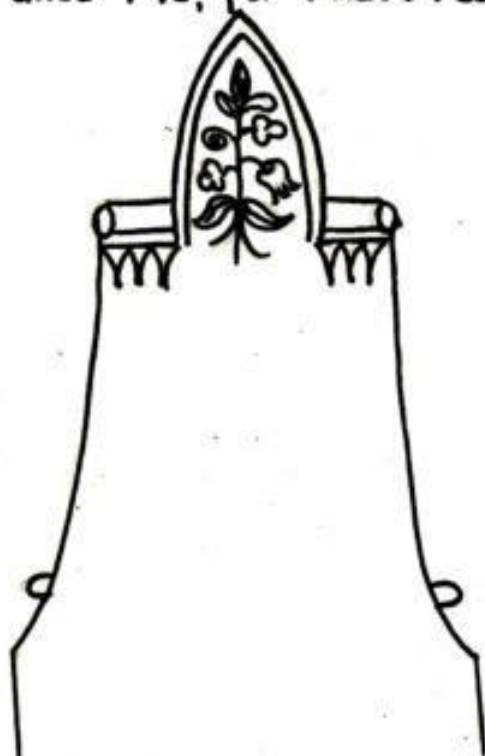

IN LOVING

MEMORY OF

WILLIAM

THIRD SON OF,
 JAMES AND MARY YARDLEY,
 BORN NOV. 18, 1856,
 DIED JAN. 21, 1880

ALSO

MARY, BELOVED WIFE OF
 HUGH RHODES,
 AND SISTER OF THE ABOVE,
 BORN OCT. 30, 1863,
 DIED JAN. 22, 1892.

BLEST ROCK OF AGES
 I'M HIDING IN THEE

ALSO OF JAMES YARDLEY, FATHER OF THE ABOVE

DIED APRIL 24, 1895, AGED 72

AND MARY, HIS WIFE

DIED DECEMBER 5, 1915, AGED 82

ROCK OF AGES CLEFT FOR ME



AFFECTIONATE REMEMBRANCE
OF
WILLIAM MORREY
OF AUDMORE VILLA, GNOSALL,
WHO ENTERED INTO REST OCT^R 5. 1904,
AGED 59 YEARS
"THY WILL BE DONE"
AND OF
LOUISA, WIDOW OF THE ABOVE
WHO PASSED TO HER REST
AT ROSEDENE UTTOXETER,
ON APRIL 4TH 1919
AGED 70 YEARS
"SHE HATH DONE WHAT SHE COULD"

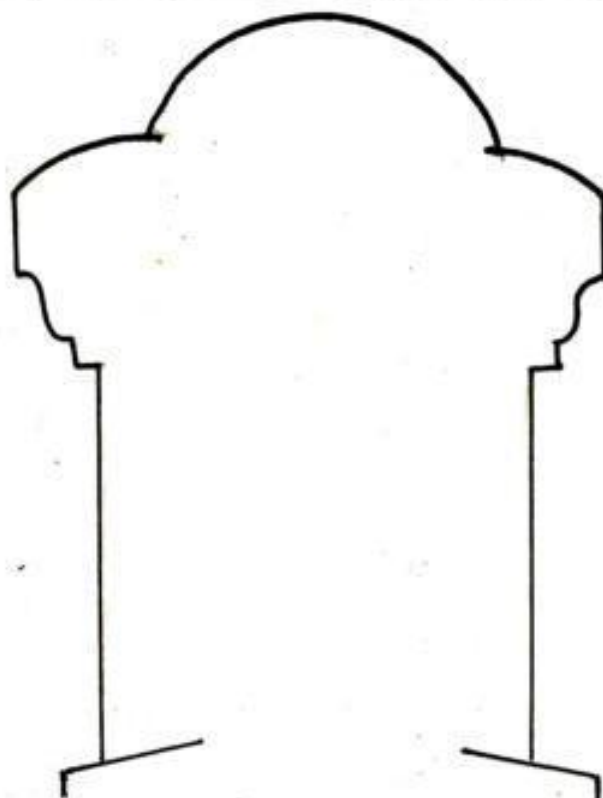

IN
LOVING REMEMBRANCE OF
JAMES MORREY,
OF GNOSALL,
WHO DEPARTED THIS LIFE ON JULY 29, 1883
AGED 69 YEARS
"NOT MY WILL BUT THINE BE DONE"
ALSO OF
ANN MORREY
WIFE OF THE ABOVE.
WHO DEPARTED THIS LIFE ON DEC. 29, 1891
AGED 82 YEARS.
HER END WAS PEACE

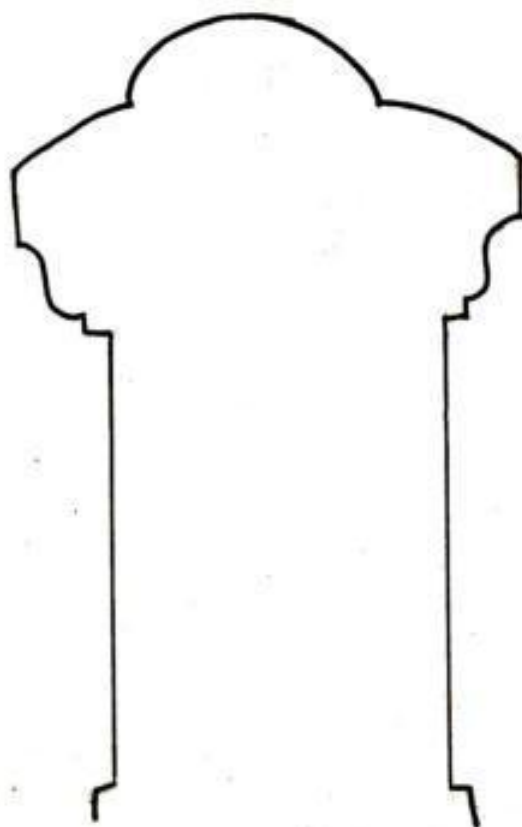

IN
LOVING MEMORY
OF
JOHN COTTON
WHO DIED MARCH 13TH 1897,
AGED 55 YEARS
ALSO OF CAROLINE, HIS WIFE,
WHO DIED JUNE 13TH 1909,
AGED 75 YEARS
"PEACE PERFECT PEACE"

